

Hybrid Car Project

Echo

By Eliam Weinstock, Holly Jossart, Chloe Obert,
Howie Fry

Hybrid Car Project

Echo

By Eliam Weinstock, Holly Jossart, Chloe Obert,
Howie Fry

Blueprint Mk. I (Hindenburg/Air Titanic model)

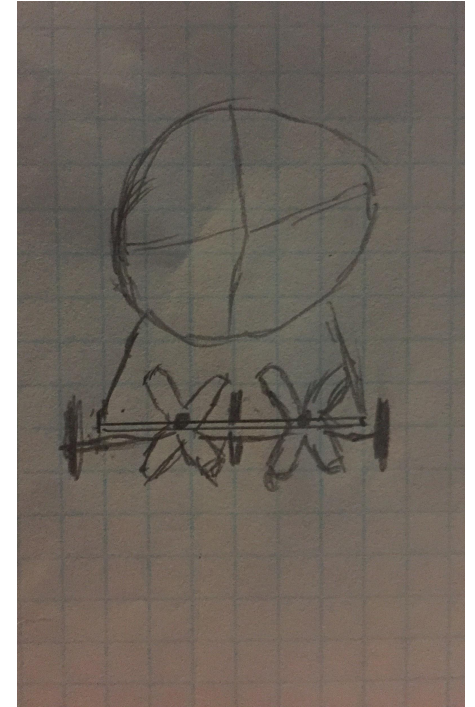
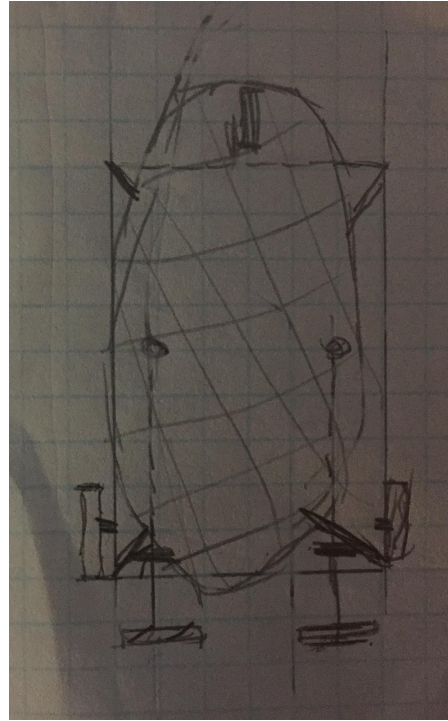
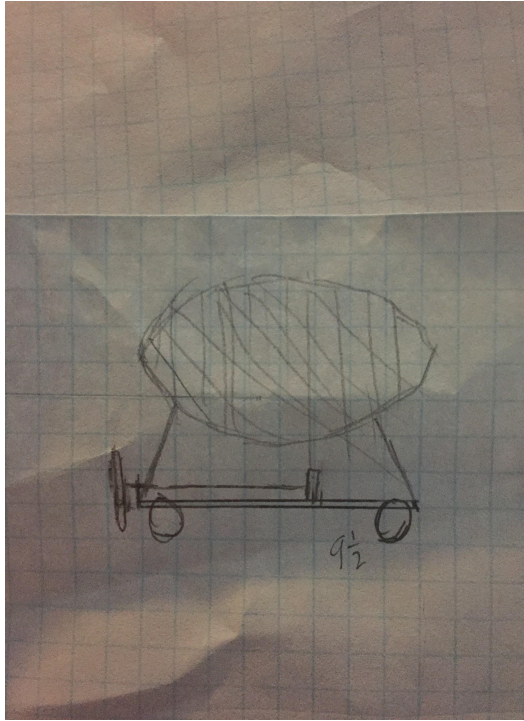

Blueprint Mk. II (Echo model)

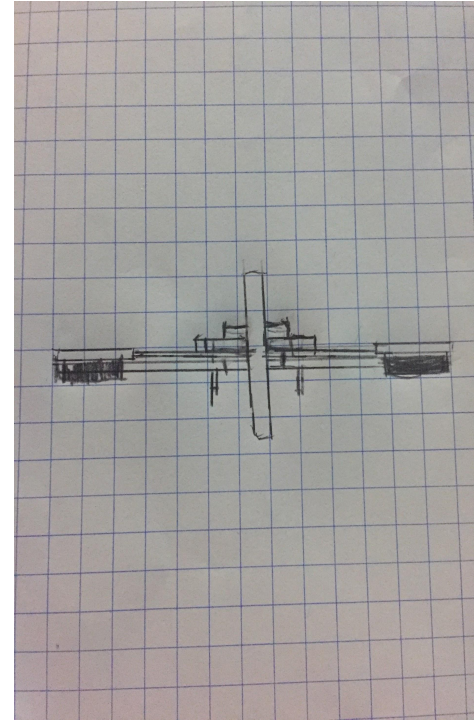
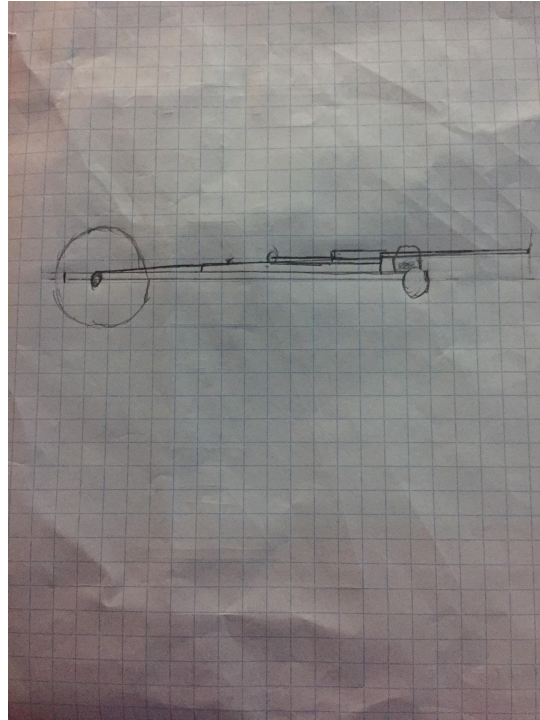
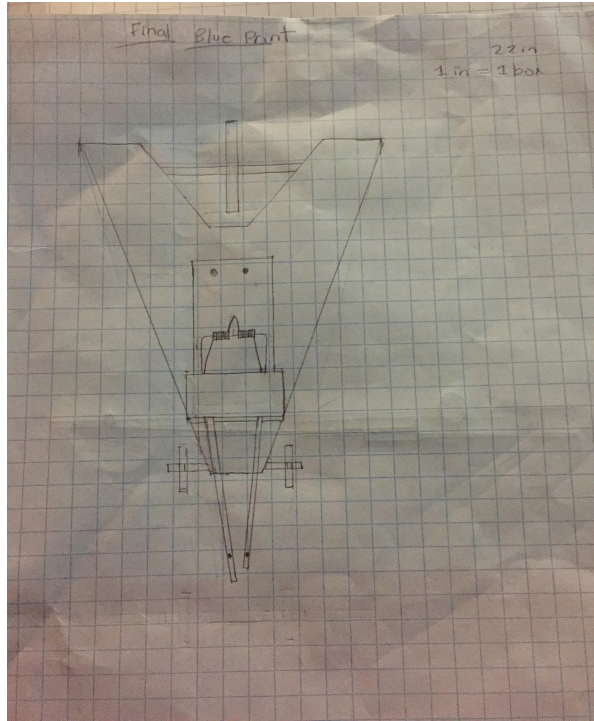

Time vs Velocity vs Distance

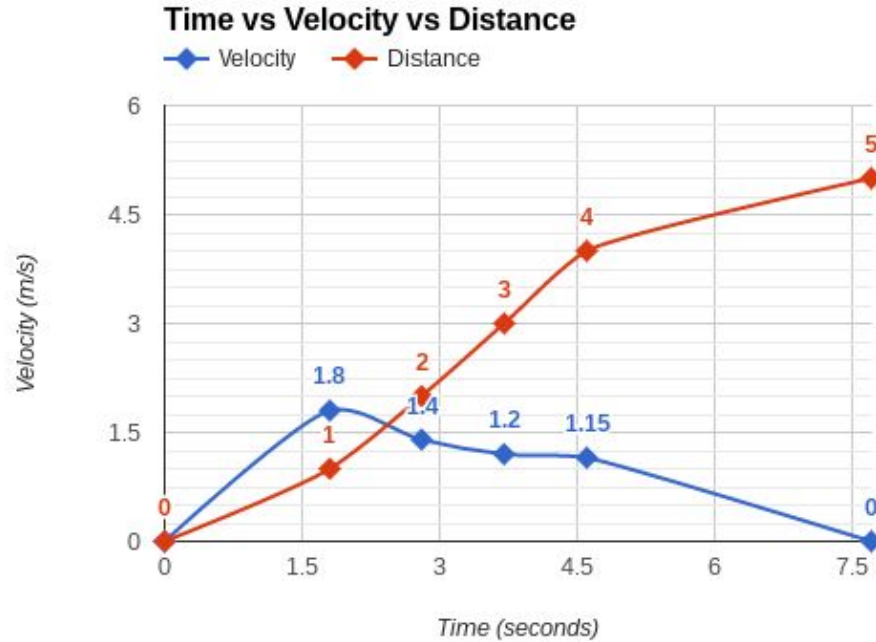

Time vs. Distance

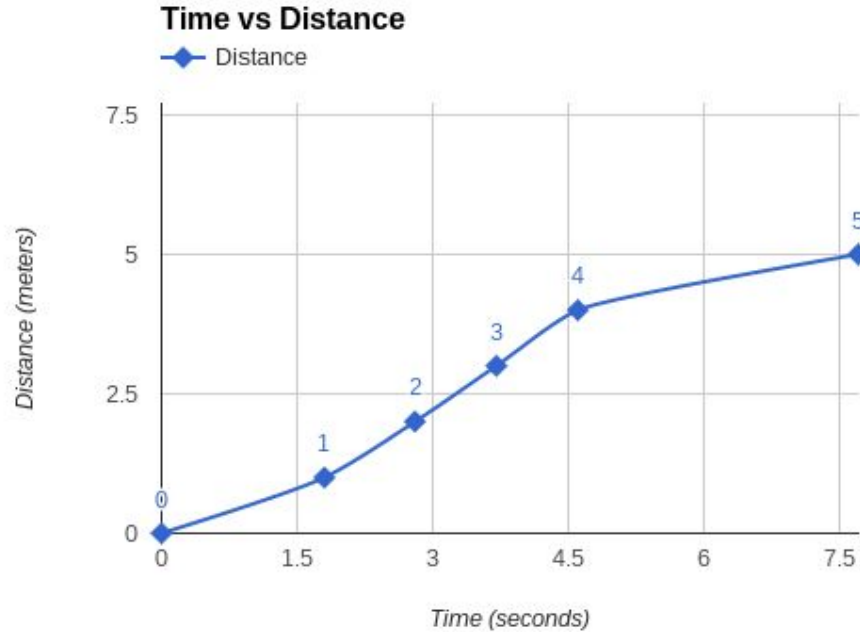

Potential Energy vs Kinetic Energy vs Total Energy

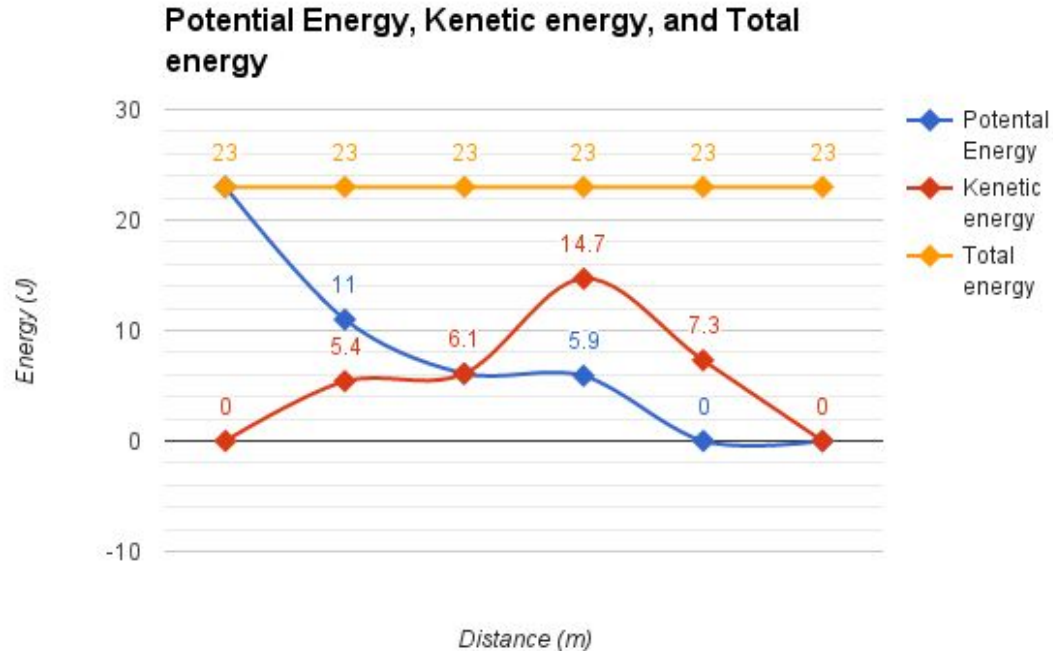

Why buy our Car?

- Consistent
- Efficient
- Cheap (\$6.47)
- No pollutants involved
- Reliable

Buy our car...

THIS IS INTENTIONAL

THIS IS NOT ACCIDENTAL

Seriously... buy it

please...

We haven't eaten in days.

Blueprint Mk. I (Hindenburg/Air Titanic model)

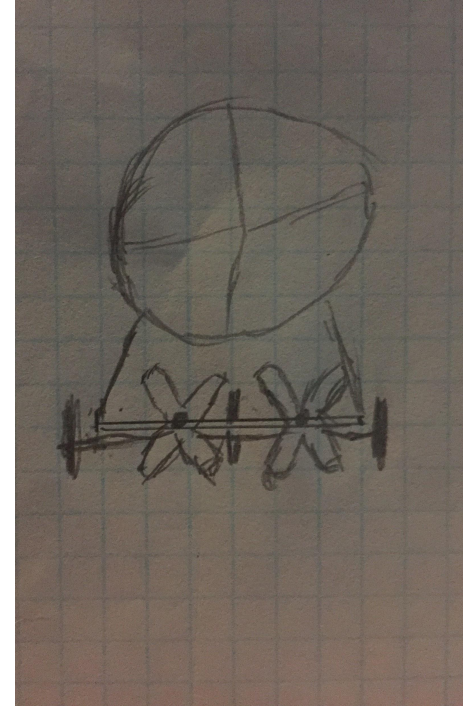
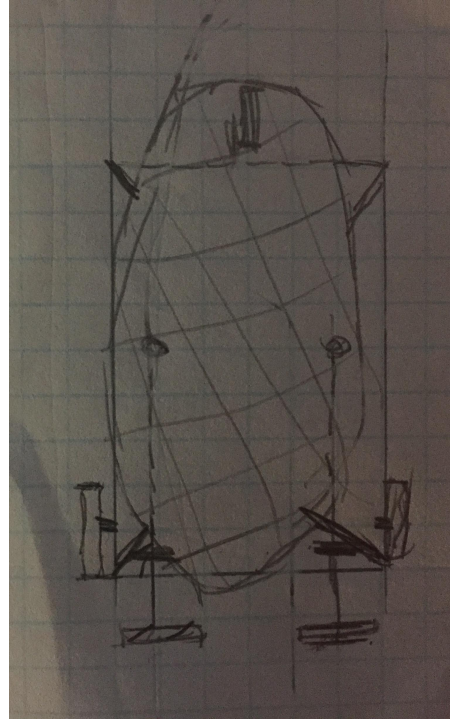
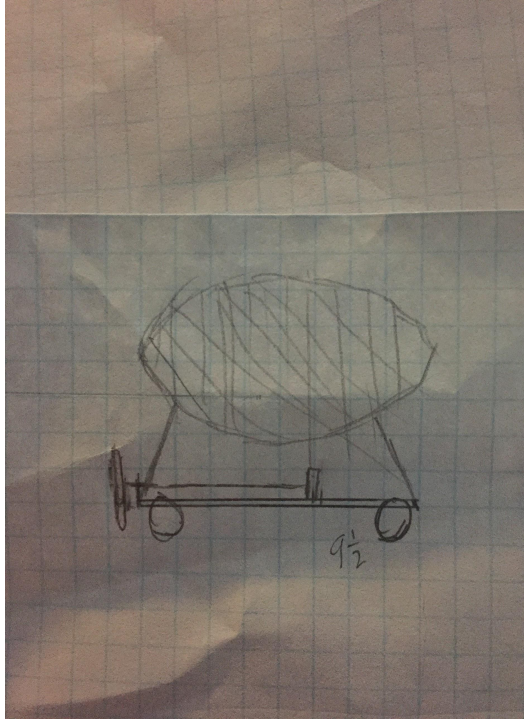

Blueprint Mk. II (Echo model)

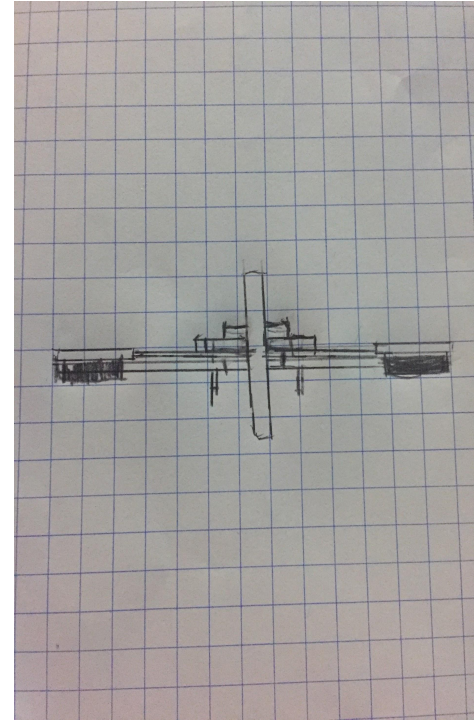
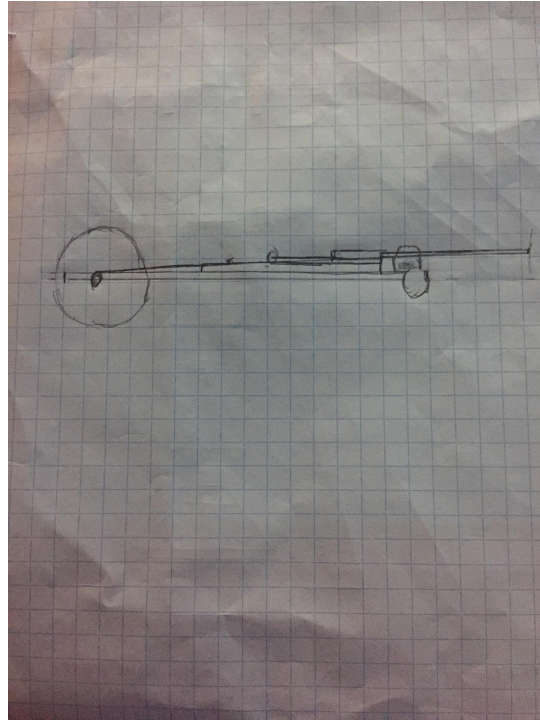
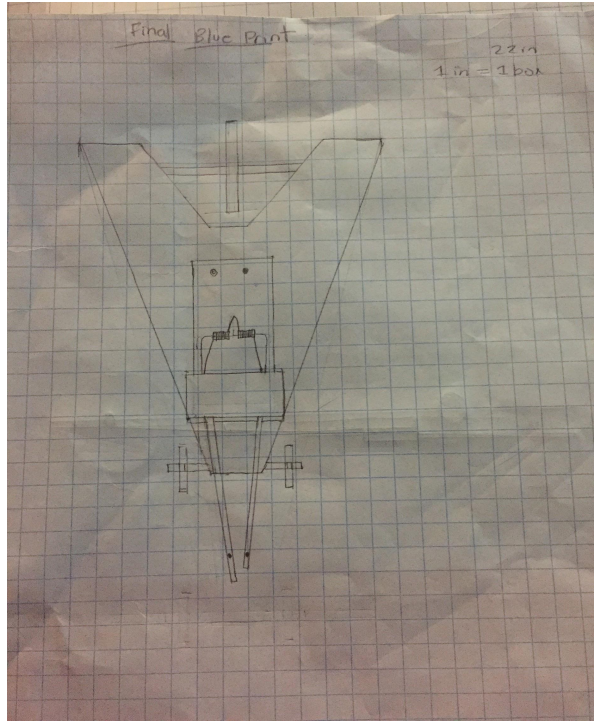

Time vs Velocity vs Distance

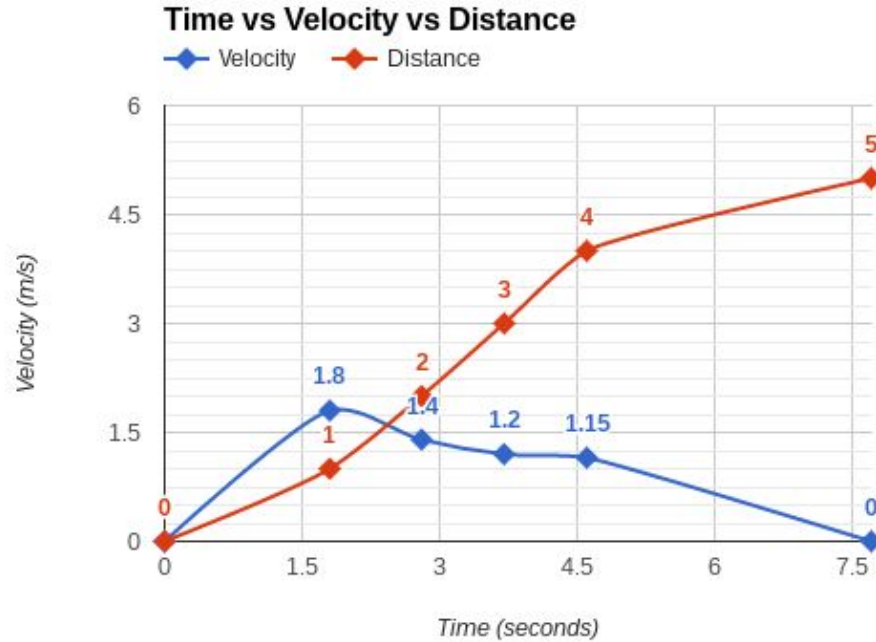

Time vs. Distance

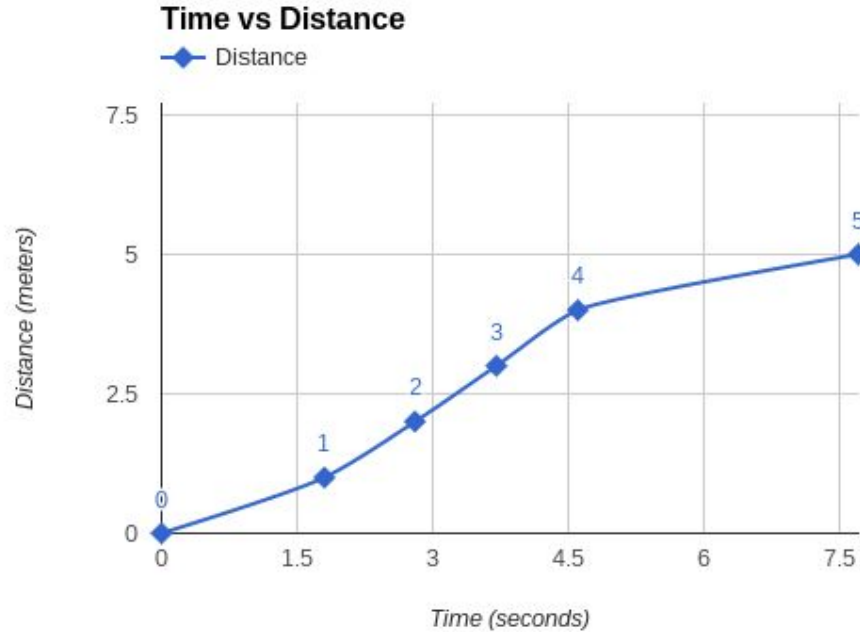

Potential Energy vs Kinetic Energy vs Total Energy

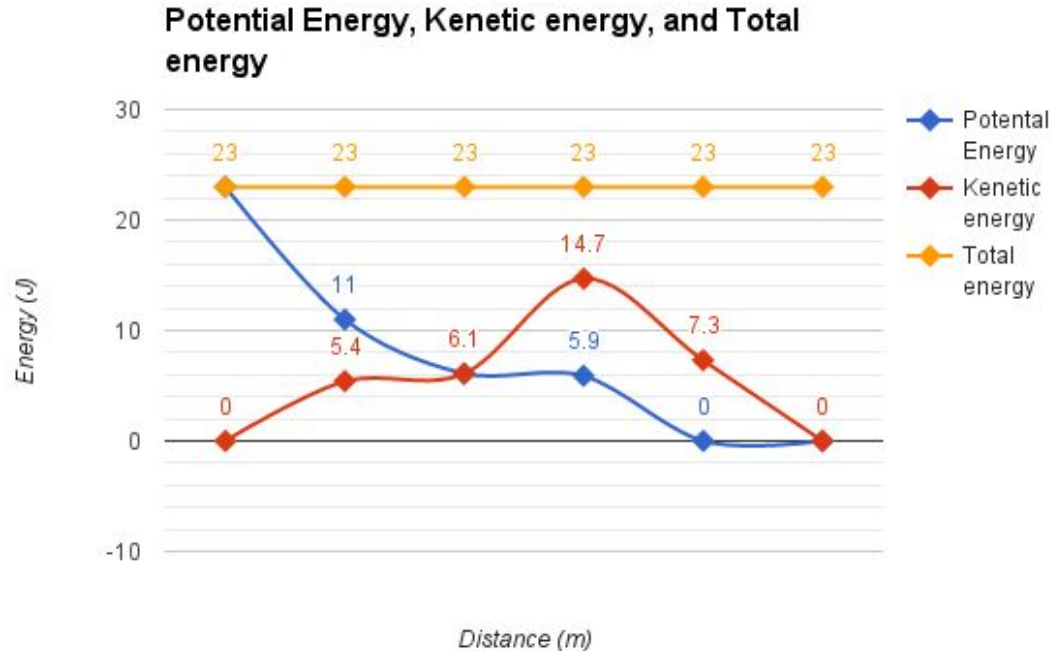

Why buy our Car?

- Consistent
- Efficient
- Cheap (\$6.47)
- No pollutants involved
- Reliable

Buy our car...

THIS IS INTENTIONAL

THIS IS NOT ACCIDENTAL

Seriously... buy it

please...

We haven't eaten in days.